



WHAT'S INCLUDED:

- 1 x LED Light Bar
- Side and Bottom Mounting Brackets
- Mounting Hardware

FEATURES & SPECIFICATIONS:

- Light Output: 8,400 Lumens
- Power: 120W @ 13.6V DC
- Current: 8.8A @ 13.6V DC
- Voltage: 9 - 36V DC
- Dimension (H,W,D): 5.5 x 51.3 x 5.8 CM
- Beam Pattern: Driving Beam

L9 SERIES BAR

4BB816
L9 SERIES BAR
20" STRAIGHT LED LIGHT BAR
WITH BACK LIGHT
COMBO BEAM

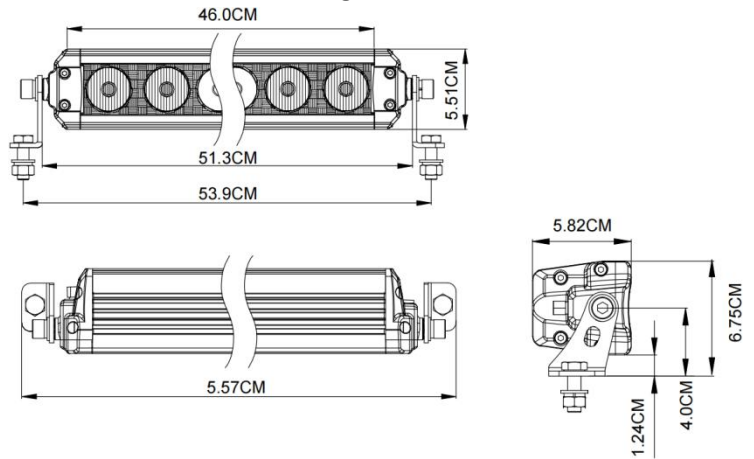

MOUNTING INSTALL INSTRUCTION

Bottom Mounts







Side Mounts

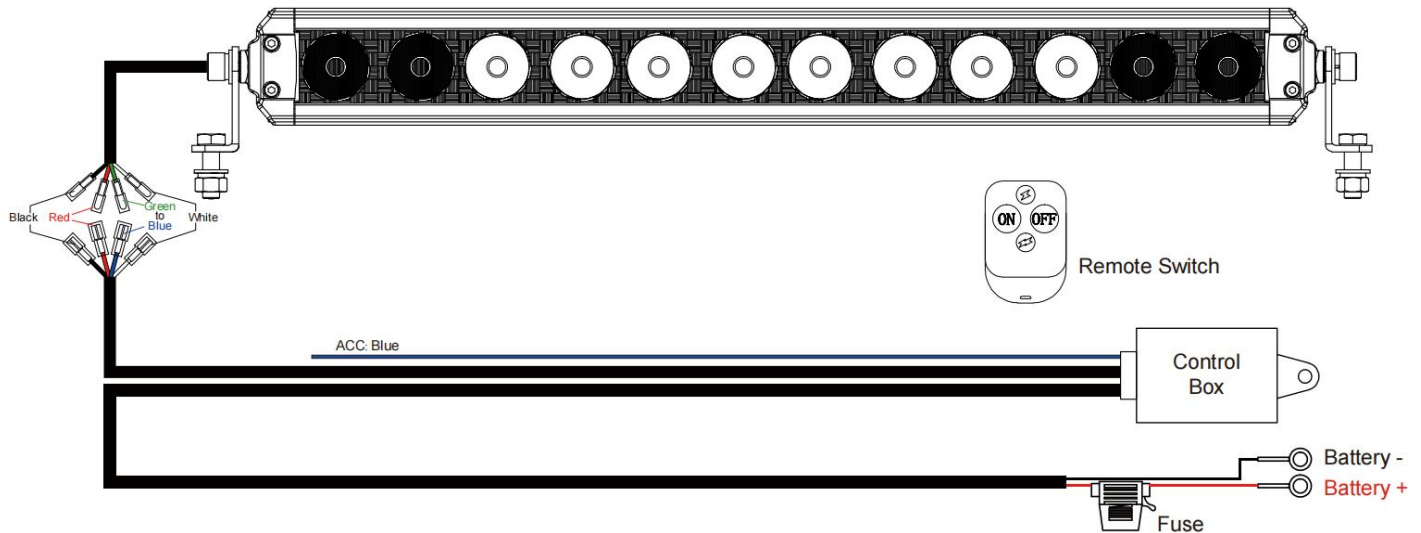

INSTALL INSTRUCTION



1. Determine suitable mounting locations to install the LED light bar, wiring harness. Once all mounting locations are confirmed, connect the wires as shown above. Connect the ACC wire to the ignition or cigarette lighter in your car. Proper insulation at connections is required.
 2. Connect positive and negative wire properly. Press the remote control switch buttons to test if each mode is functioning properly.
 3. Press  to turn on the main beam, then press  to change the main beam into strobe function.
 4. Press  to turn on the backlit function, then press  to change into next color, there are total 6 colors: White, Green, Blue, Purple, Red and Yellow. Long press for 5 seconds can turn current backlit into breathing mode.
 5. Adjust the light to the desired angle and then secure by tightening all mounting screws.
- (**Note:** In the case when some backlight LEDs are not lit or not fully illuminated, press  and hold for 10 seconds to initiate a reset.)